

## Chapter 10. INSTALLATION AND WIRING

### 10.1 Installation

#### 10.1.1 Installation Environment

This unit has high reliability regardless of its installation environment, but be sure to check the following for system reliability and stability.

##### 1) Environment requirements

Avoid installing this unit in locations which are subjected or exposed to :

- (1) Water leakage and dust.
- (2) Continuous shocks or vibrations.
- (3) Direct sunlight.
- (4) Dew condensation due to rapid temperature change.
- (5) Higher or lower temperatures outside the range of 0 to 55 °C
- (6) Relative humidity outside the range of 5 to 95 %
- (7) Corrosive or flammable gases

##### 2) Precautions during installing.

- (1) During drilling or wiring, do not allow any wire scraps to enter into the PLC.
- (2) Install it on locations that are convenient for operation.
- (3) Make sure that it is not located on the same panel that high voltage equipment located..
- (4) Make sure that the distance from the walls of duct and external equipment be 50 mm or more.
- (5) Be sure to be grounded to locations that have good ambient noise immunity.

##### 3) Heat protection design of control box

- (1) When installing the PLC in a closed control box, be sure to design heat protection of control box with consideration of the heat generated by the PLC itself and other devices.
- (2) It is recommended that filters or closed heat exchangers be used.

The following shows the procedure for calculating the PLC system power consumption.

1) PLC system power consumption block diagram

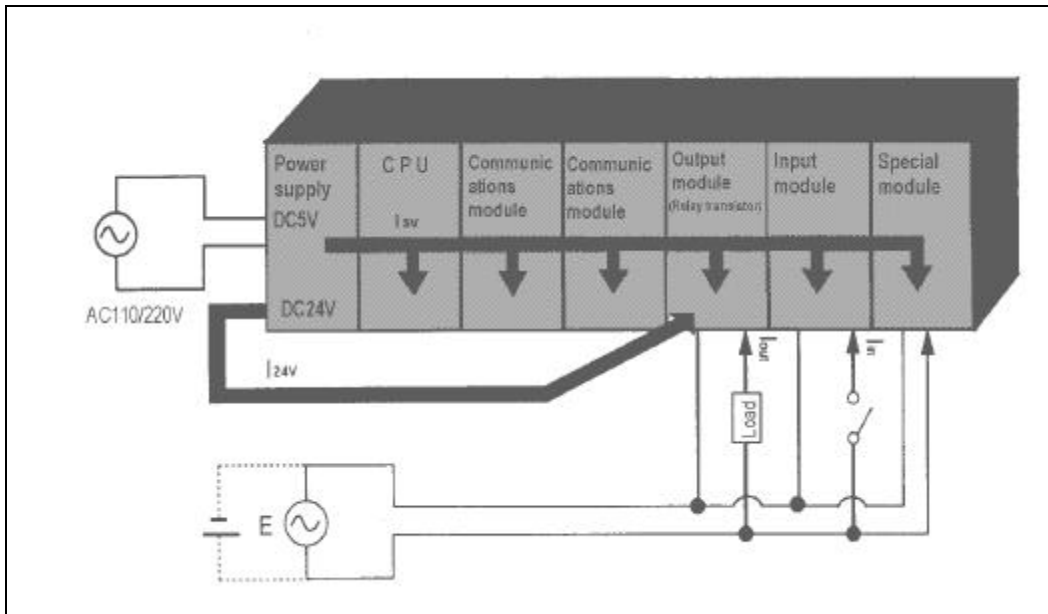

2) Power consumption of each part

(1) Power consumption of a power supply module

Approximately 70% of the power supply module current is converted into power and 30% of that 70% dissipated as heat, i.e., 3/7 of the output power is actually used.

- $W_{pw} = 3/7 \{ (I_{5V} \times 5) + (I_{24V} \times 24) \}$  (W)

where,  $I_{5V}$  = 5 VDC circuit current consumption of each module

$I_{24V}$  = 24 VDC circuit average current consumption of output modules (with points simultaneously switched ON). Not for 24 VDC power supplied from external or power supply modules that has no 24 VDC output.

(2) Total 5 VDC power consumption

The total power consumption of all modules is the power of the 5 VDC output circuit of the power supply module.

- $W_{5V} = I_{5V} \times 5$  (W)

(3) Average 24 VDC power consumption (with points simultaneously switched ON)

The total power consumption of all modules is the average power of the 24 VDC output circuit of the power supply module.

- $W_{24V} = I_{24V} \times 24$  (W)

(4) Average power consumption by voltage drop of output modules (with points simultaneously switched ON)

- $W_{out} = I_{out} \times V_{drop} \times \text{output points} \times \text{the rate of points switched on simultaneously}$  (W)

- $I_{out}$  : output current (actual operating current) (A)
    - $V_{drop}$  : voltage dropped across each output load (V)

(5) Average power consumption of input circuits if input modules (with points simultaneously switched ON)

- $W_{in} = I_{in} \times E \times \text{input points} \times \text{the rate of points switched on simultaneously (W)}$

{  $I_{in}$  : input current (effective value for AC) (A)  
 {  $E$  : input voltage (actual operating voltage) (V)

(6) Power consumption of the special module power supply

- $W_s = I_{5V} \times 5 + I_{24V} \times 24 + I_{100V} \times 100 \text{ (W)}$

The sum of the above values is the power consumption of the entire PLC system.

- $W = W_{PW} + W_{5V} + W_{24V} + W_{OUT} + W_{IN} + W_s \text{ (W)}$

Check the temperature rise within the control panel with calculation of that total power consumption(W).

The temperature rise in the control panel is expressed as:

$$T = W/UA \text{ [}^\circ\text{C]}$$

{  $W$  : Power consumption of the entire PLC system (obtained as shown above)  
 {  $A$  : Control panel inside surface area (m<sup>2</sup>)  
 {  $U$  : 6 (if the control panel temperature is controlled by a fan, etc.)  
 4 (if control panel air is not circulated)

10.1.2 Handling Instructions

To installing the temperature-measuring resistor input module, be sure to check the following:

- Do not drop it off, and make sure that strong shock should not be applied.
- Do not unload the PCB from its case. It can cause faults.
- During wiring, be sure to check any foreign matter like wire scraps should not enter into the upper side of the PLC. If any foreign matter has entered into it, always eliminate it.
- Do not load or unload the module while the power supply is being connected.

1) I/O module handling instructions

The followings explains instructions for handling or installing the input module.

(1) I/O module specifications re-check

Re-check the input voltage for the input module. If a voltage over the maximum switching capacity is applied, it can cause faults, destruction or fire.

(2) Used wire

Select the wire with due consideration of ambient temperature and rated current. Its minimum specifications should be AWG22(0.3 mm<sup>2</sup>) or more.

(3) Environment

When wiring the I/O module, if it locates near a device generating an cause short circuit, destruction or malfunction.

(4) Polarity

Before applying the power to a module that has polarities, be sure to check its polarities.

(5) Wiring

- Wiring I/O wires with high voltage cable or power supply line can cause malfunction or disorder.
- Be sure that any wire does not pass across during input LED (I/O status will not be clearly identified).
- If an inductive load has been connected to output module, connect parallel surge killer or diode to a load. Connect the cathode part of diode to the + part of the power supply.

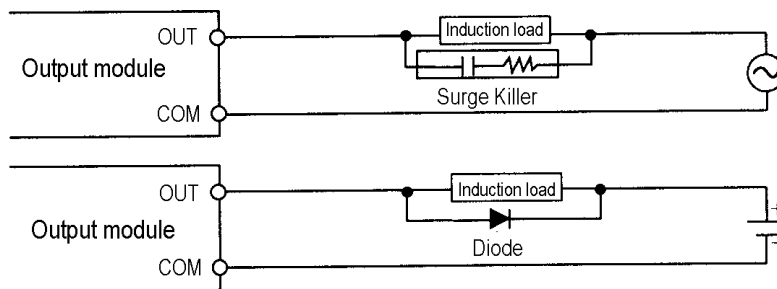

(6) Terminal block

Check its fixing. During drilling or wiring, do not allow any wire scraps to enter into the PLC. It can cause malfunction and fault.

(7) Be cautious that strong shock does not applied to the I/O module. Do not separate the PCB from its case.

**2) Base board mounting instructions**

The following explains instructions for mounting the PLC onto the control panel.

- (1) Allow sufficient distance from the upper part of the module for easy module replacement.
- (2) Do not mount the PLC in a vertical or horizontal position because it affects on ventilation.
- (3) Do not mount the base board together with a large-sized electromagnetic contact or no-fuse breaker, which produces vibration, on the same panel. Mount them on different panels, or keep the base board away from such a vibration source.
- (4) Mount the wire duct as it is needed.

If the clearances are less than those in Fig 10.1, follow the instructions shown below.

- If the wire duct is mounted on the upper part of the PLC, make the wiring duct clearance 50mm or less for good ventilation. Also, allow the distance enough to press the hook in the upper part from the upper part of the PLC.
  - If the wire duct is mounted on the lower part of the PLC, make optic or coaxial cables contact it and consider the minimum diameter of the cable.
- (5) To protect the PLC from radiating noise or heat, allow 100 mm or more clearances between it and parts. Left or right clearance and clearance from other device in the left or right side should be 50 mm or more.

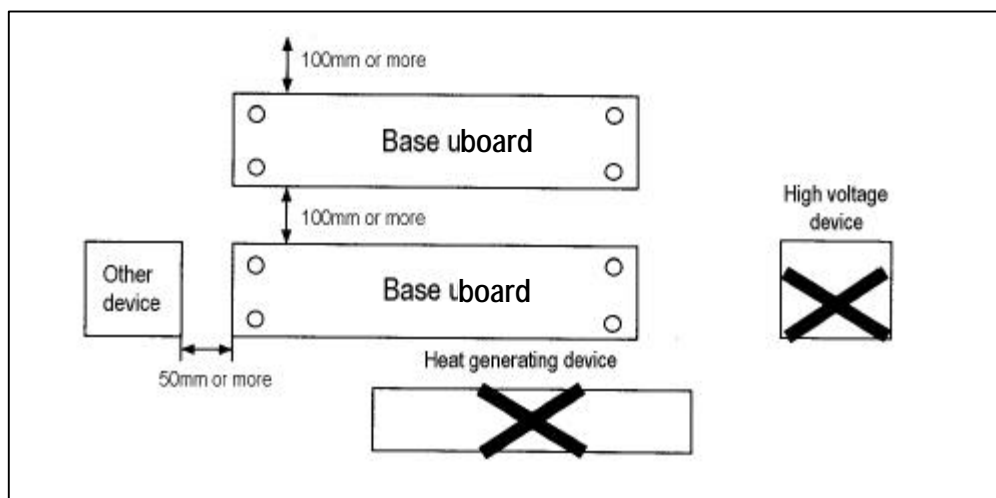

[Fig. 10.1] PLC mounting

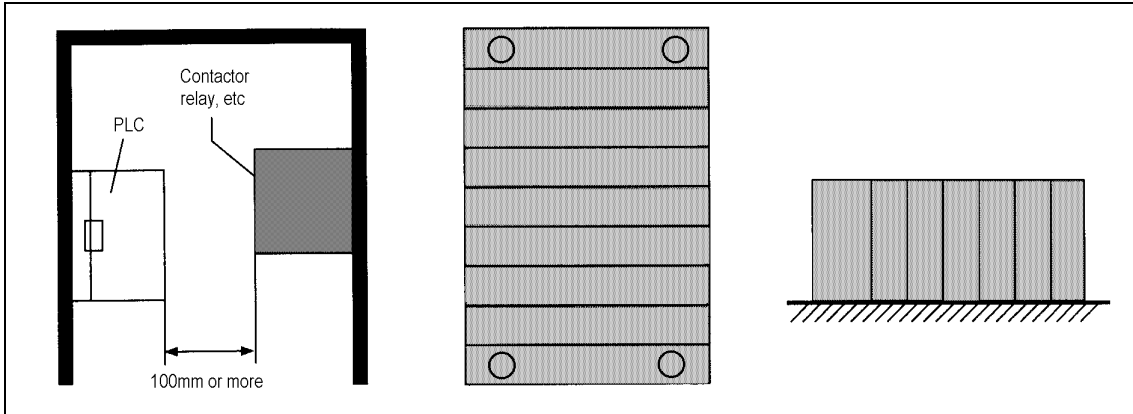

[Fig.10.2] Clearance from the front device

[Fig. 10.3] Vertical mounting

[Fig 10.4] Horizontal mounting

### 10.1.3 Mounting and Dismounting of module

The following explains the mounting and dismounting of various modules.

#### 1) Module mounting

- Insert the module to mounting slot with sliding guide.
- Check that the module is firmly mounted onto the base board.

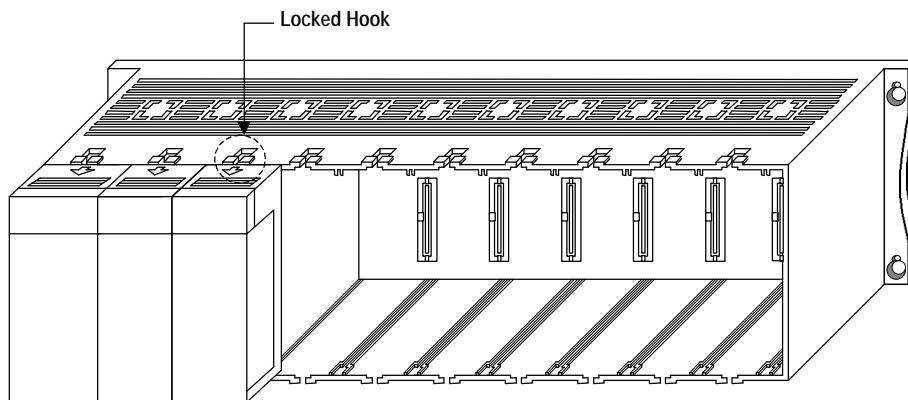
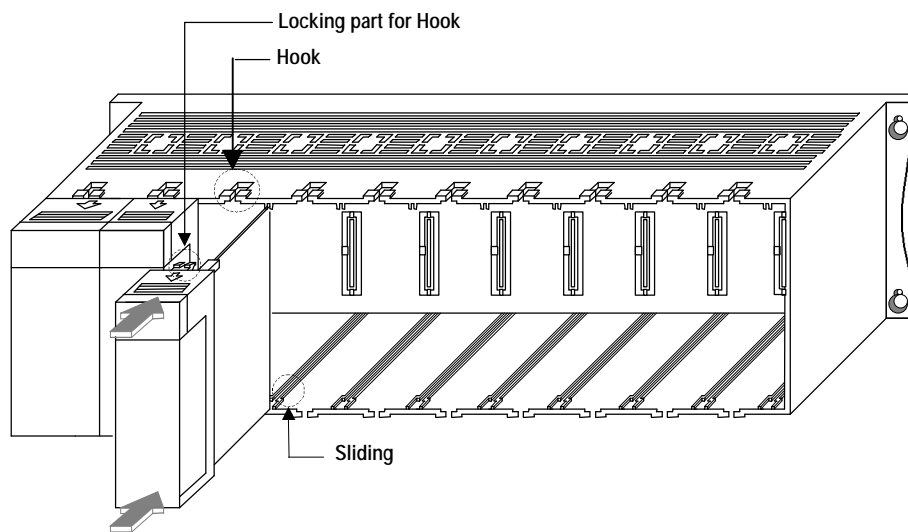

## 2) Module dismounting

- First, push the locked hook (a) and pull the module with direction of arrow (b)

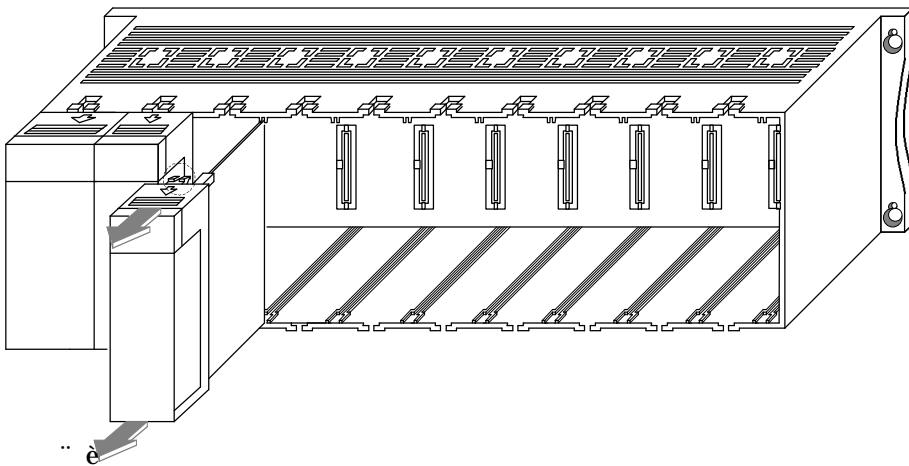
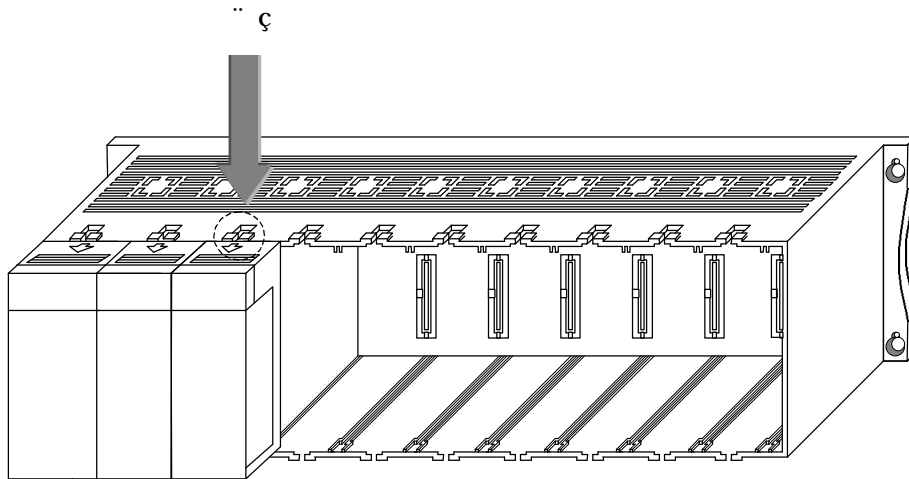

## 10.2 Wiring

The followings explains the wiring instructions for use of the system.

### 10.2.1 Power Supply Wiring

- 1) When voltage fluctuations are larger than the specified value, connect a constant-voltage transformer.

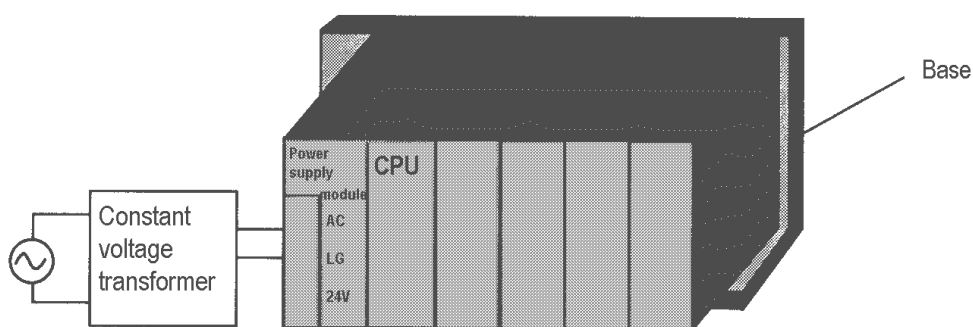

- 2) Use a power supply which generates minimal noise across wire and across PLC and ground. (When excessive noise is generated, connect an insulating transformer)
- 3) When wiring, separate the PLC power supply from the I/O and power device as shown below.

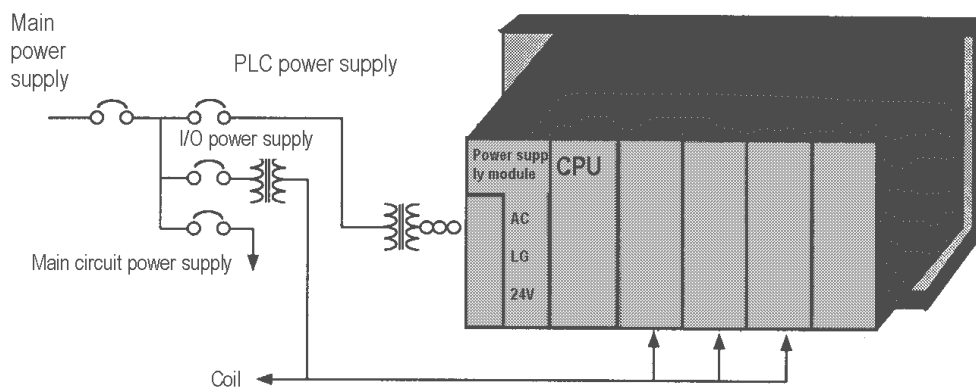

4) Notes on using 24 VDC output of the power supply module

- To protect the power supply modules, do not supply one I/O module with 24 VDC from several power supply modules connected in parallel.
- If 24 VDC output capacity is sufficient for one power supply module, supply 24 VDC from the external 24 VDC power supply as shown below.

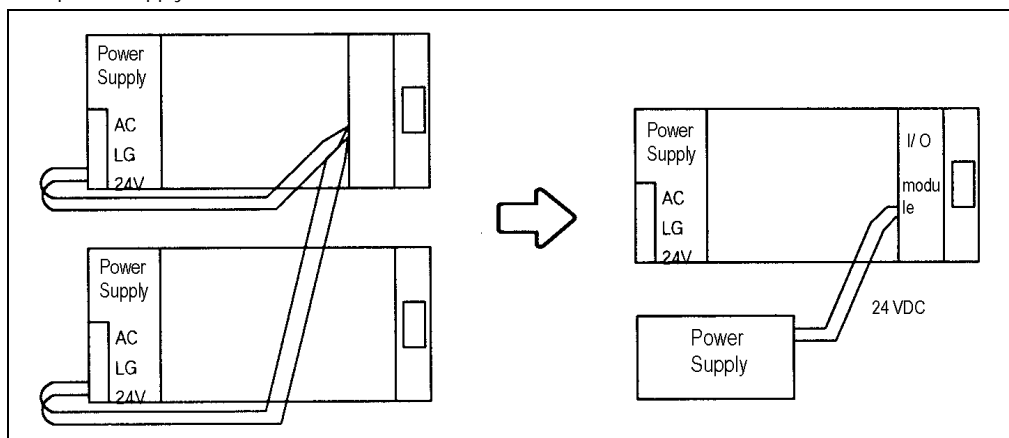

- 5) Twist the 110 VAC, 220 VAC, and 24 VDC cables as closely as possible. Connect modules with the shortest possible wire lengths.
- 7) To minimize voltage drop, use the thickest (max. 2 mm<sup>2</sup>) wires possible for the 100 VAC, 200VAC and 24 VDC cables.
- 8) Do not bundle the 100 VAC and 24 VDC cables with main-circuit(high voltage, large current) wires or the I/O signal wires. If possible, provide more than 100 mm distance between the cables and wires.
- 8) As a lightning-protection measure, connect a surge absorber as shown below.

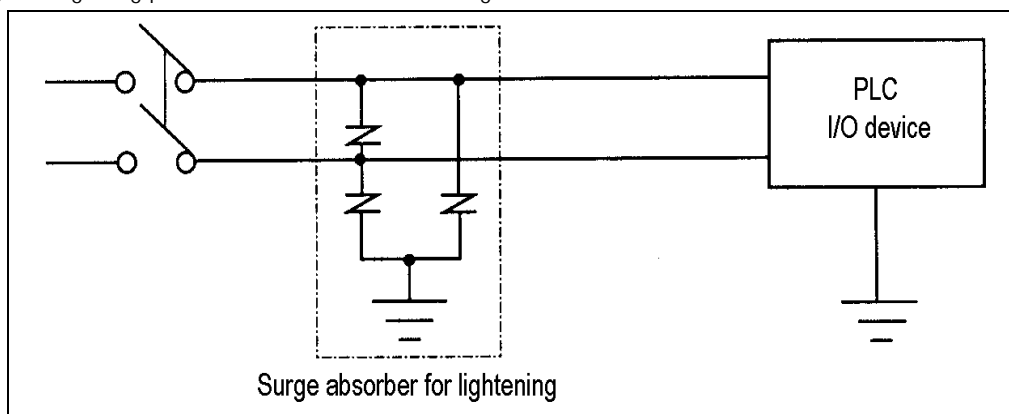

**REMARK**

- 1) Ground the surge absorber (E1) and the PLC(E2) separately from each other.
- 2) Select a surge absorber making allowances for power voltage rises.

- 9) Use a insulating transformer or noise filter for protection against noise .
- 10) Twist every input power supply wires as closely as possible. Do not allow the transformer or noise filter across the duct.

10.2.2 Input and Output Devices Wiring

- 1) Applicable size of wire for I/O wiring is 0.3 to 2 mm<sup>2</sup>. However, it is recommended to use wire of 0.3mm<sup>2</sup> for convenience.
- 2) Separate the input and output lines.
- 3) I/O signal wires must be at least 100 mm away from high voltage and large current main circuit wires.
- 4) When the I/O signal wires cannot be separated from the main circuit wires and power wires, ground on the PLC side with batch-shielded cables.

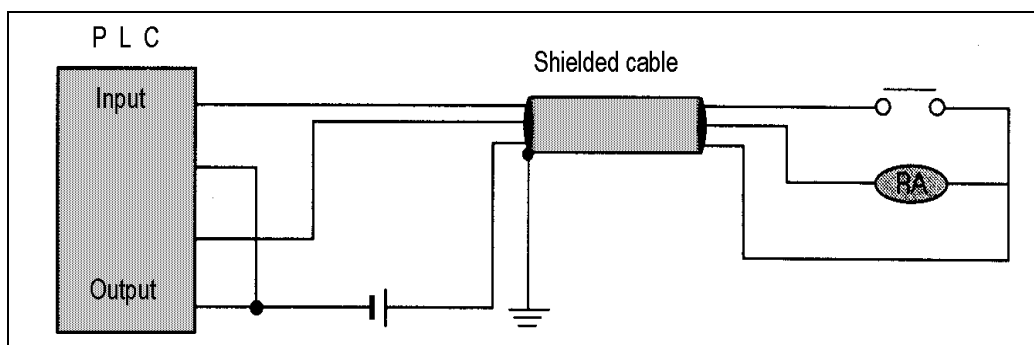

- 5) If wiring has been done with a piping, ground the piping.
- 6) Separate the 24 VDC I/O cables from the 110 VAC and 220 VAC cables.
- 7) If wiring over 200 m or longer distance, problems can be caused by leakage currents due to line capacity. Refer to the Section 12.4 Examples.

10.2.3 Grounding

- 1) This PLC has sufficient protection against noise, so it can be used without grounding except for special much noise. However, when grounding it should be done conforming to below items.
- 2) Ground the PLC as independently as possible. Class 3 grounding should be used (grounding resistance 100 Ω or less).
- 3) When independent grounding is impossible, use the joint grounding method as shown in the figure below (B).

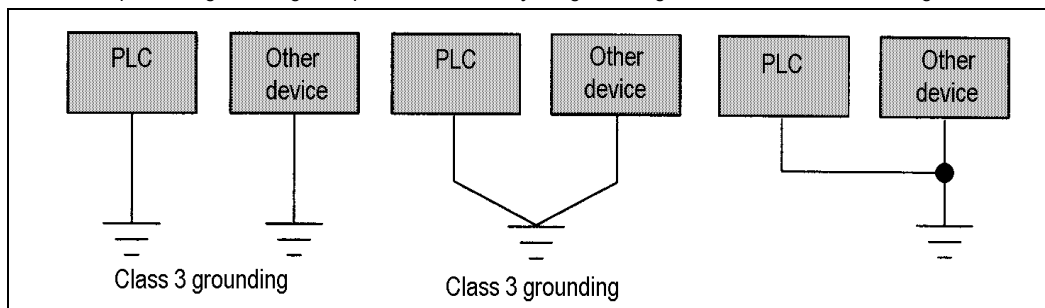

(A) Independent grounding : Best (B) Joint grounding : Good (C) Joint grounding : Not allowed

- 4) Use 2 mm<sup>2</sup> or more wire for grounding line. Make the distance as short as possible with the grounding point located to nearest to the PLC.

5) Ground LG (Power Supply Module) separately with FG (Base board).

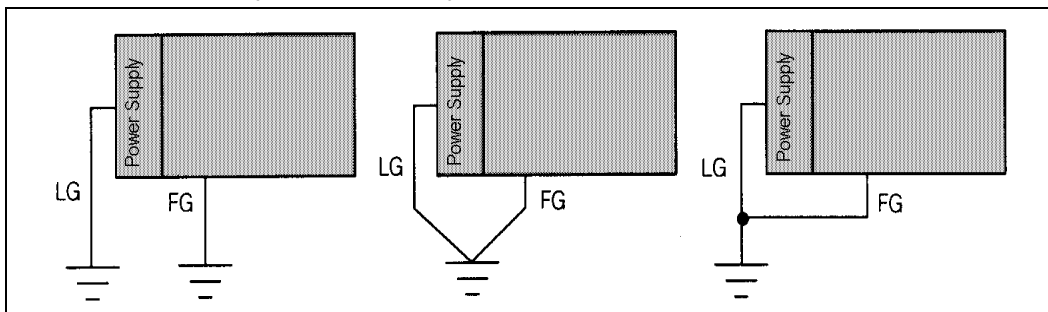

(A) Independent grounding : BEST (B) Joint grounding : GOOD (C) Joint Grounding : Not Allowed

6) If a malfunction occurs depend on grounding point, separate FG (Base Board) with ground.

10.2.4 Cable Specifications for wiring

Kinds of external connection	Cable Specifications (S ɸ)	
	Minimum	Maximum
Digital Input	0.18 (AWG 24)	1.5 (AWG16)
Digital Output	0.18 (AWG24)	2.0 (AWG14)
Analog Input/Output	0.18 (AWG24)	1.5 (AWG16)
Communication	0.18 (AWG24)	1.5 (AWG16)
Main Power	1.5 (AWG16)	2.5 (AWG12)
Grounding	1.5 (AWG16)	2.5 (AWG12)